

# TECHNICAL DRAWING

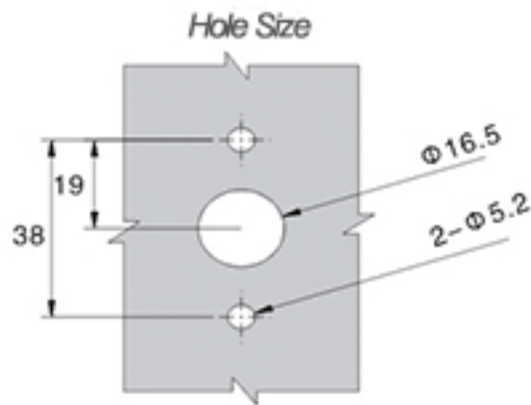
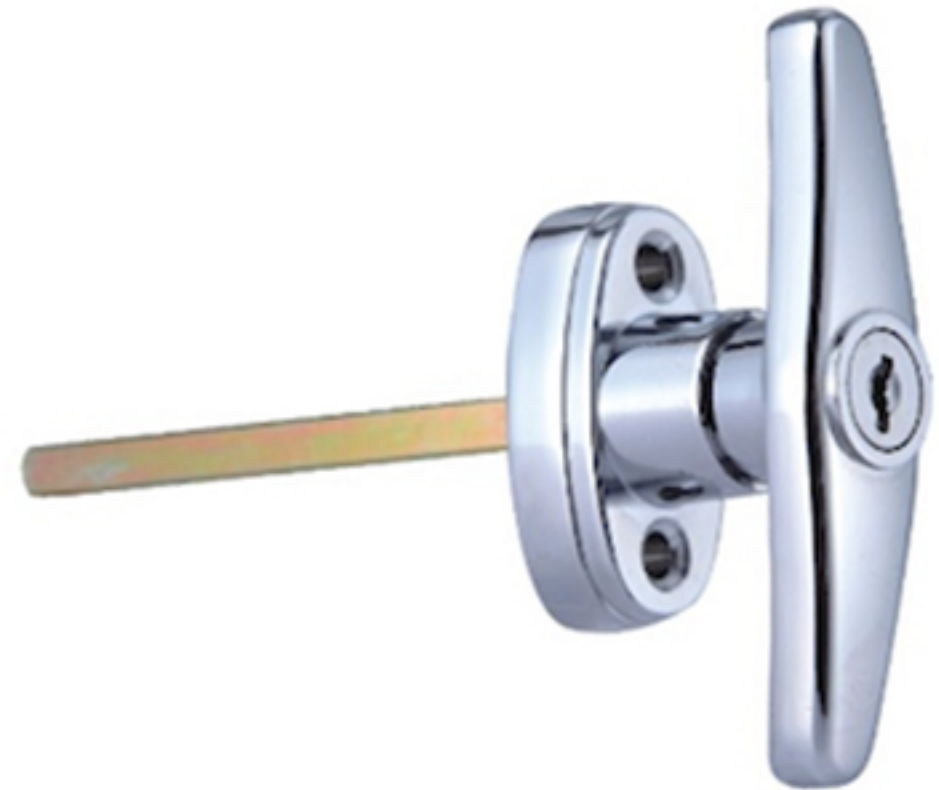
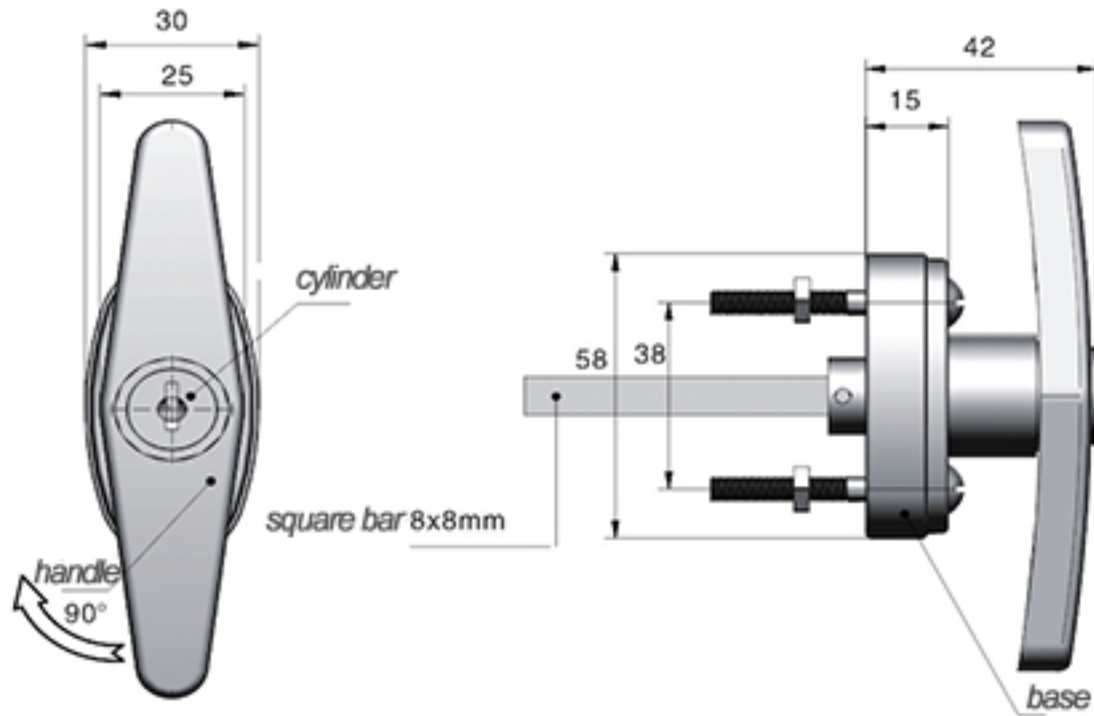

**Tower Industry**  
YOUR MANUFACTURING BASE IN CHINA

Sales@tower-machinery.com  
www.tower-machinery.com

**TW330-B**  
Handle Lock

**MATERIA:** ZDC base, handle, cylinder. Steel shaft.  
**SURFACE:** Chrome plated cylinder, handle and base.  
Zinc plated shaft.  
**REMARK:** 90 degree turn achieve open and lock.