

TECHNICAL DRAWING

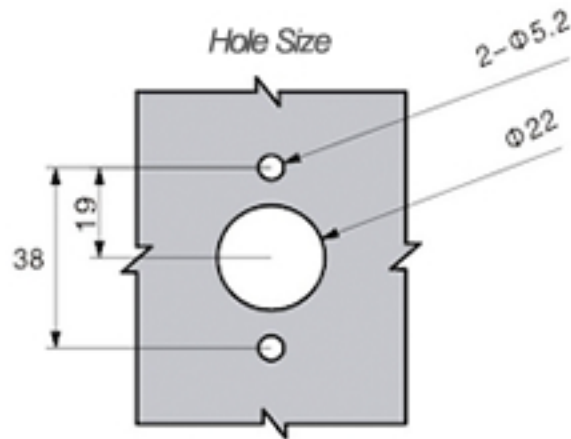
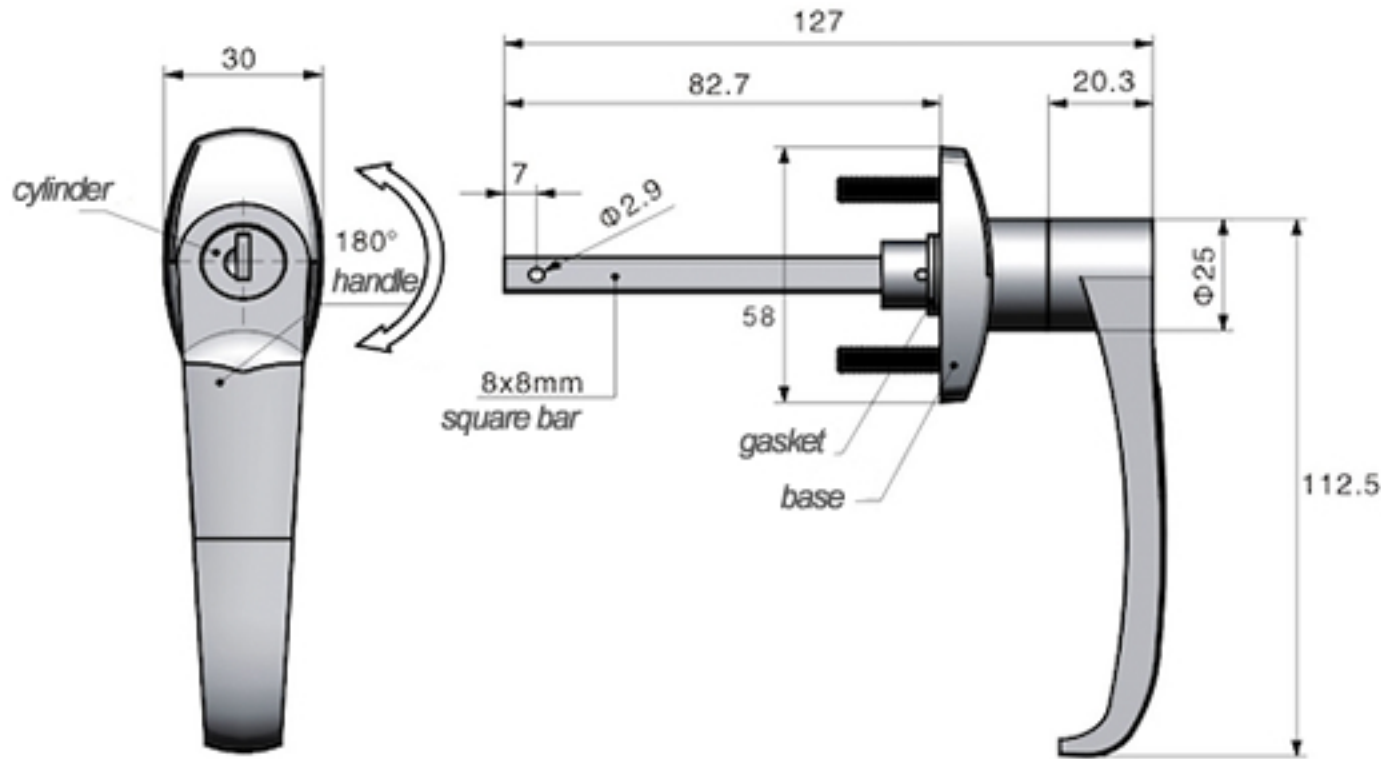

Tower Industry
YOUR MANUFACTURING BASE IN CHINA

Sales@tower-machinery.com
www.tower-machinery.com

TW328-B
Handle Lock

MATERIA: ZDC base, handle, cylinder. Steel shaft.
SURFACE: Chrome plated cylinder, handle and base.
Zinc plated shaft.
REMARK: 90 degree turn achieve open and lock.