

TECHNICAL DRAWING

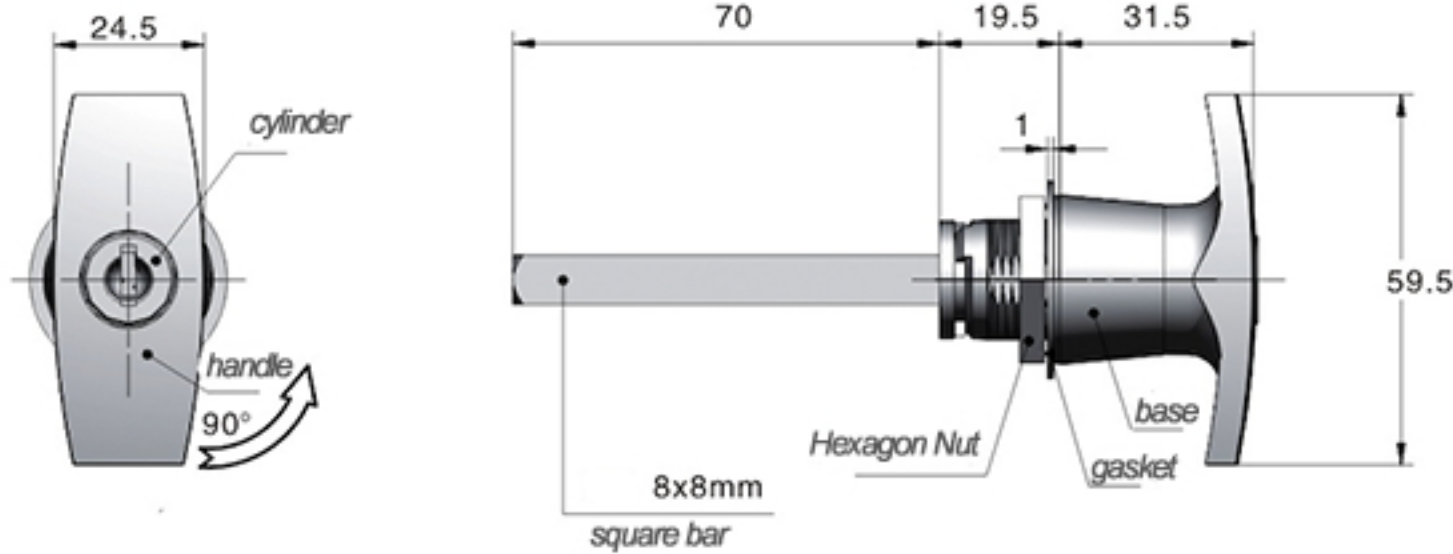

TW313-B-1

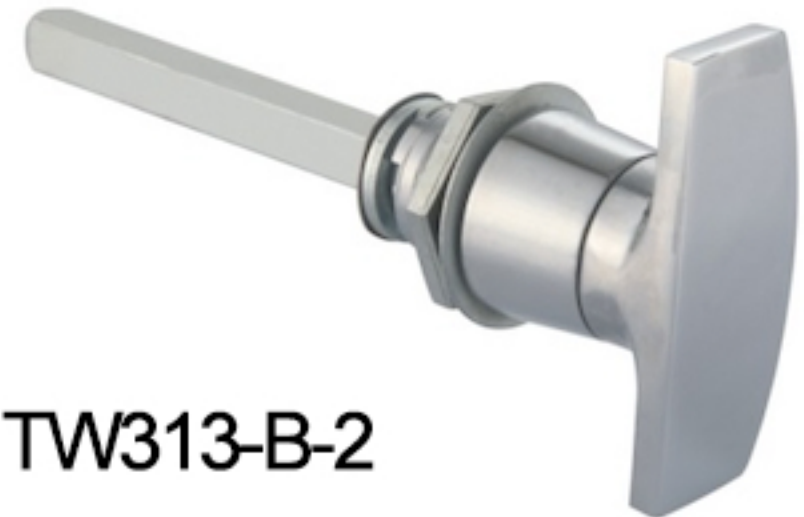
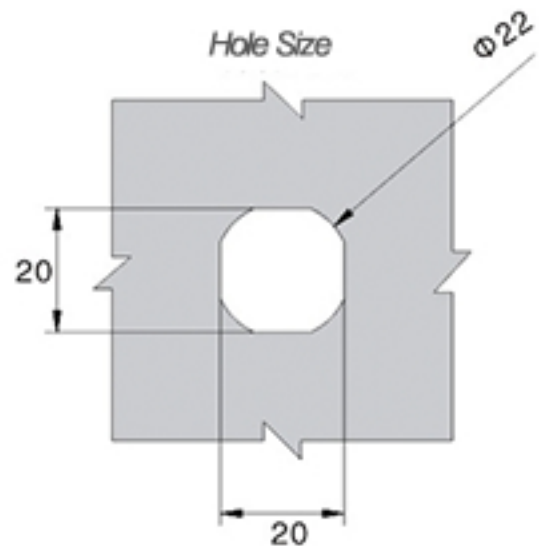

TW313-B-2

Tower Industry
YOUR MANUFACTURING BASE IN CHINA

Sales@tower-machinery.com
www.tower-machinery.com

Handle Lock

MATERIAL: ZDC base, handle, cylinder. Steel shaft.
SURFACE: Chrome plated cylinder, handle and base.
Zinc plated shaft.
REMARK: 90 degree turn achieve open and lock.
RH/LH open