

TECHNICAL DRAWING

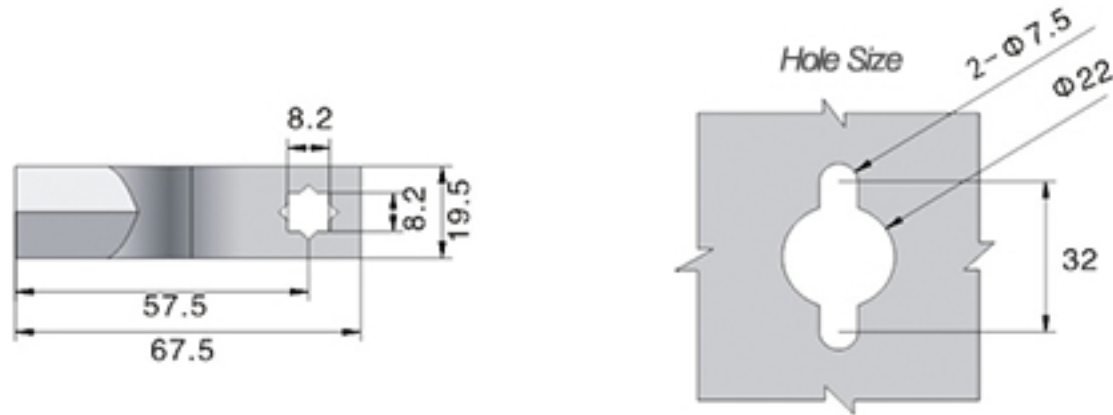
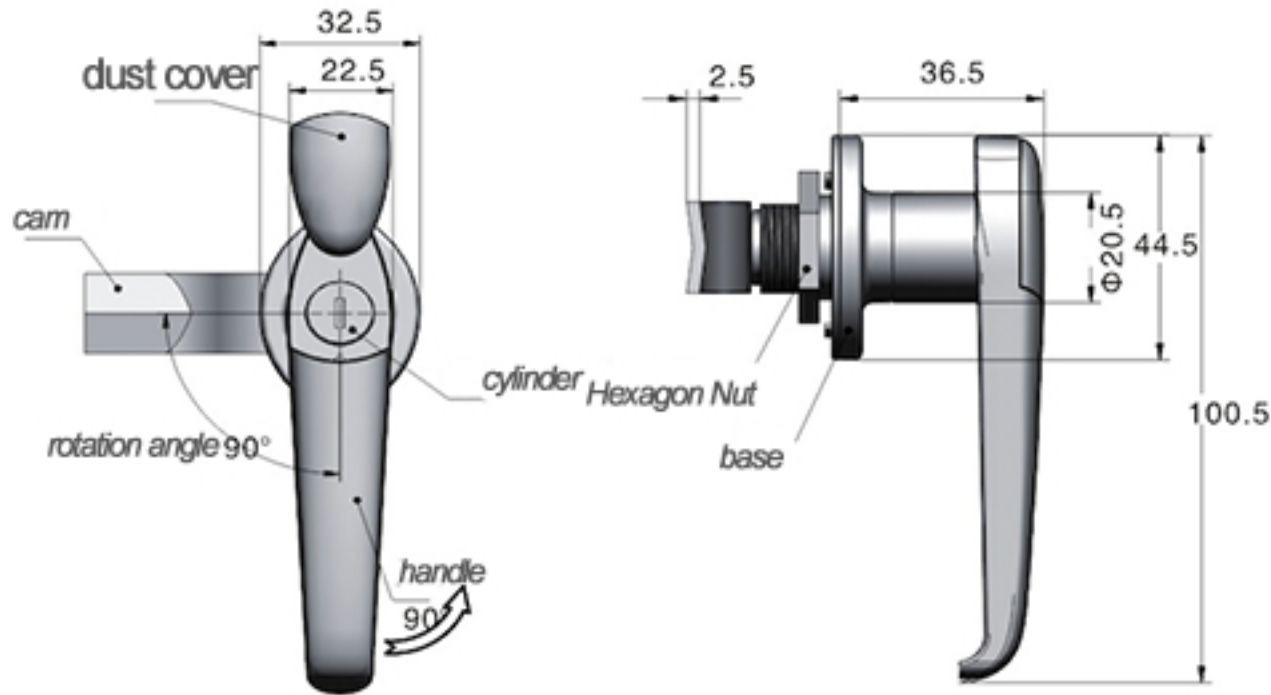

Tower Industry
YOUR MANUFACTURING BASE IN CHINA

Sales@tower-machinery.com
www.tower-machinery.com

TW308
Handle Lock

MATERIAL: ZDC base, handle and cylinder. Steel cam.
SURFACE: Chrome plated base, handle and cylinder.
Zinc plated cam.

REMARK: 90 degree turn achieve open and lock